

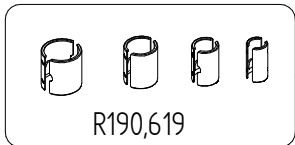

ART. 055CXPRO3

For serial number
from A1351025
to A3076637

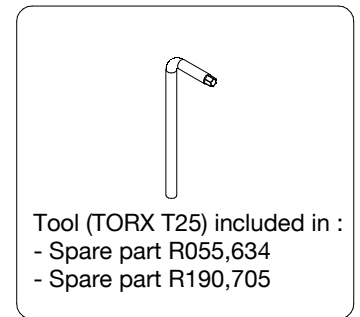
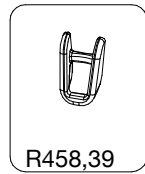
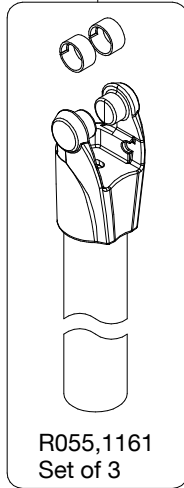
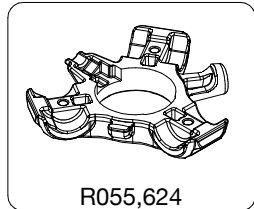
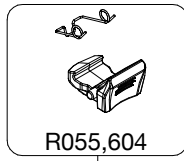
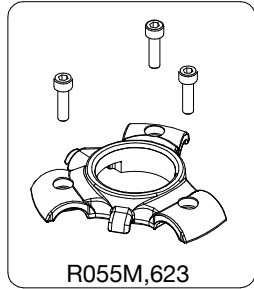
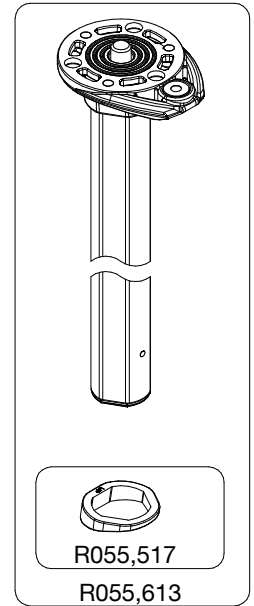
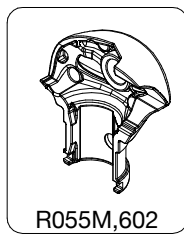
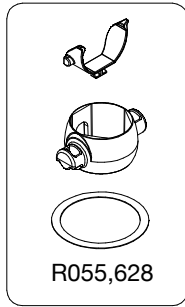

TO BE MOUNTED
ON TUBES
(1 LEG)

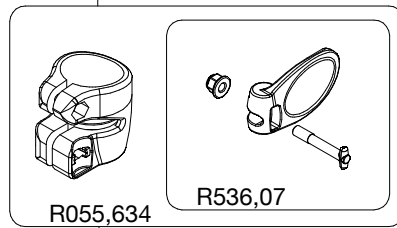

TO BE MOUNTED
ON CLAMPING-COLLARS
(1LEG)

