

VERSIONE: 004
DEL: 2003-07-30

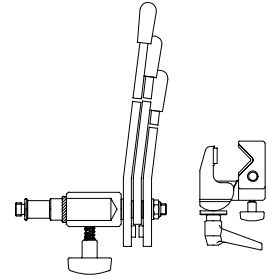

FOR BACKLITE SPARE LIST SEE DRAWING: ART.003

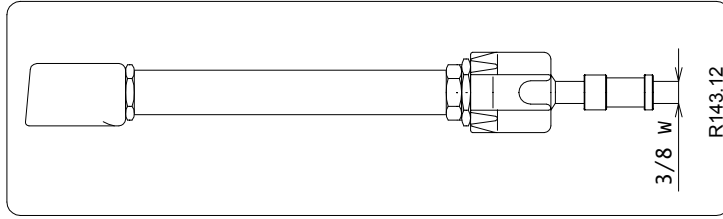
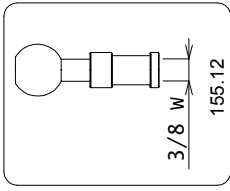
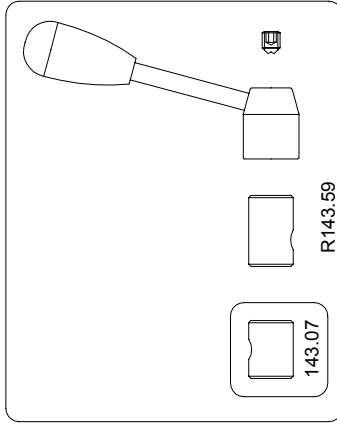
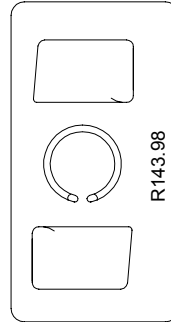
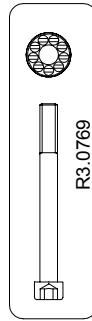
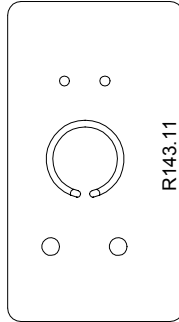
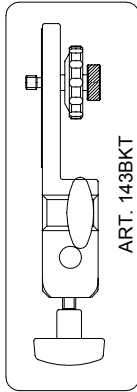
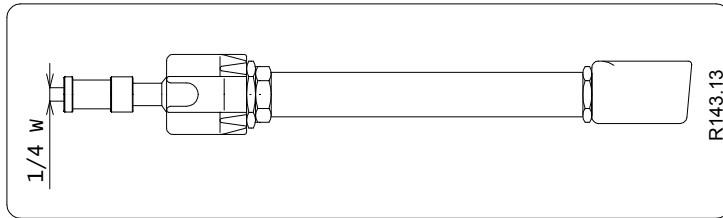
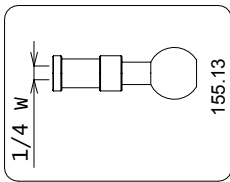
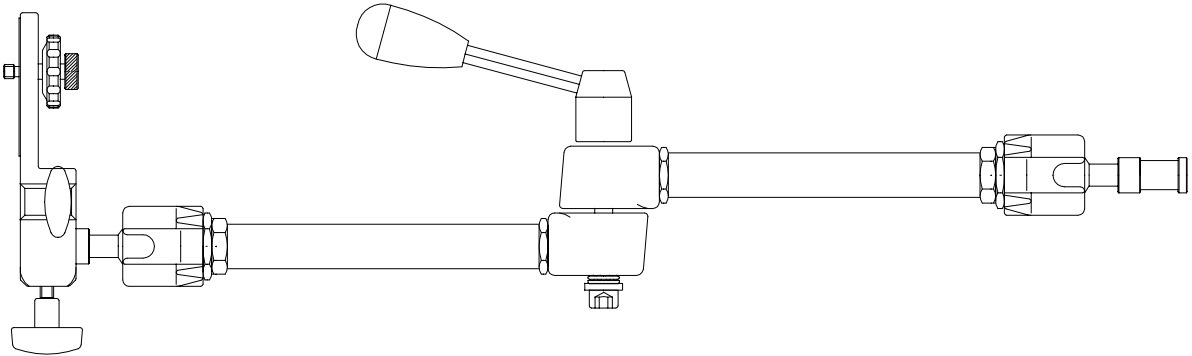
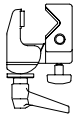

FOR SUPER CLAMP SPARE LIST SEE DRAWING: ART.035