

# Manfrotto nord

ART.  
117X

VERSIONE: 008  
DEL: 2001-03-26

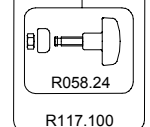
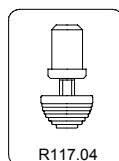
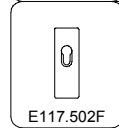
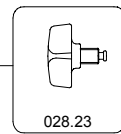
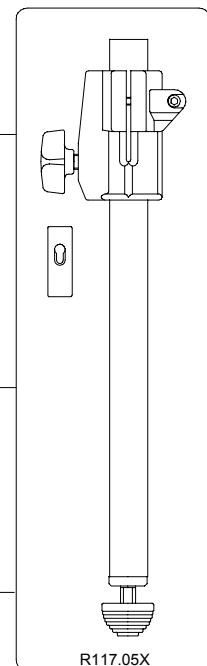
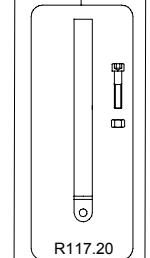
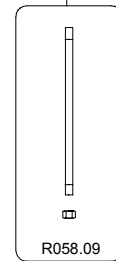
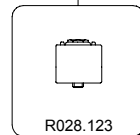
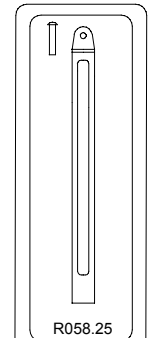
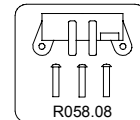
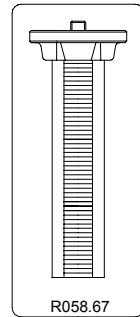
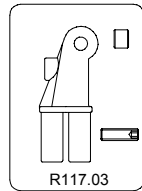
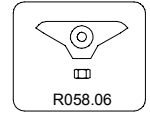
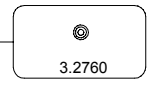
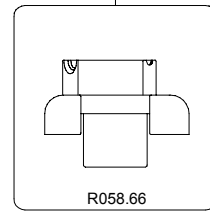
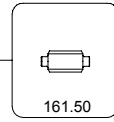
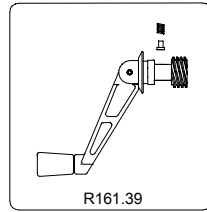
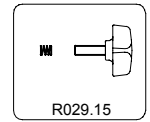
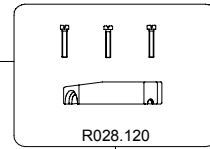
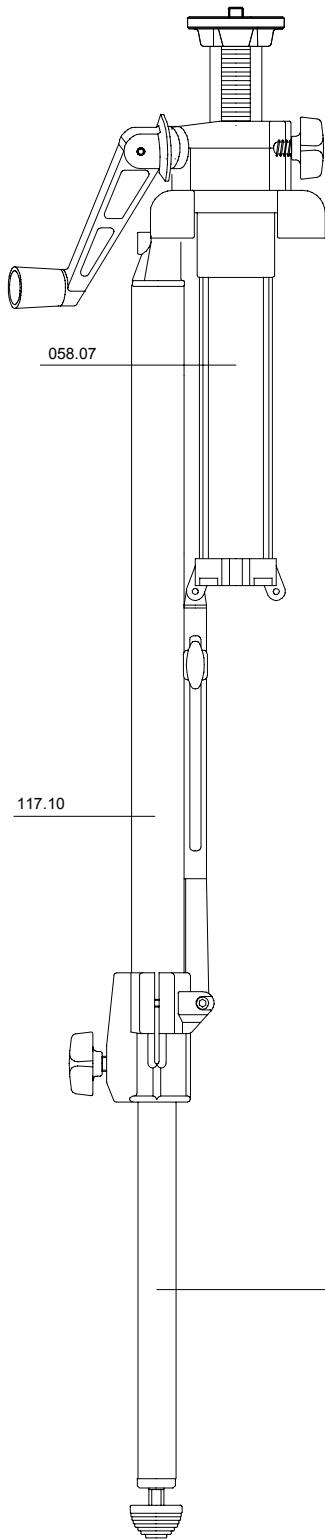

R117.100