

2005-09-30

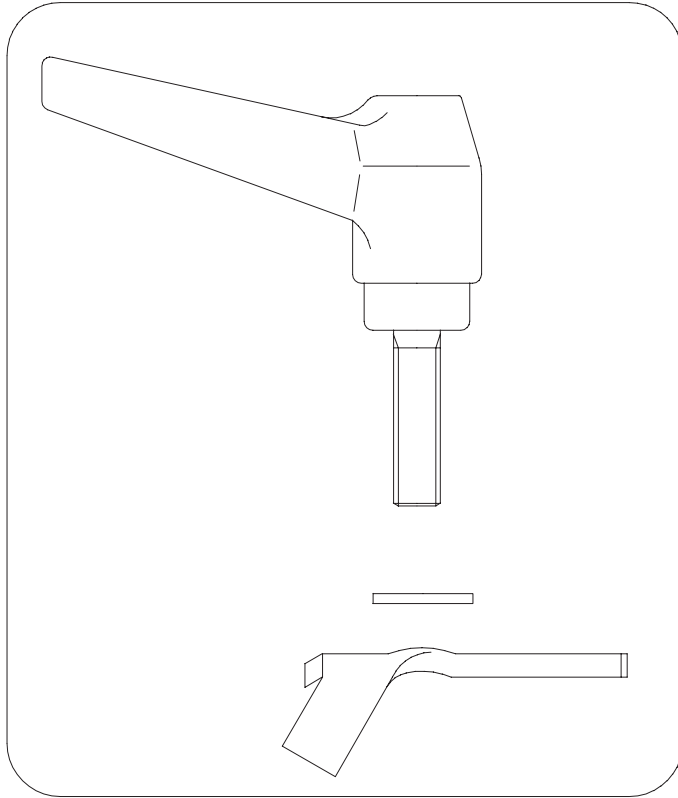

R022,03

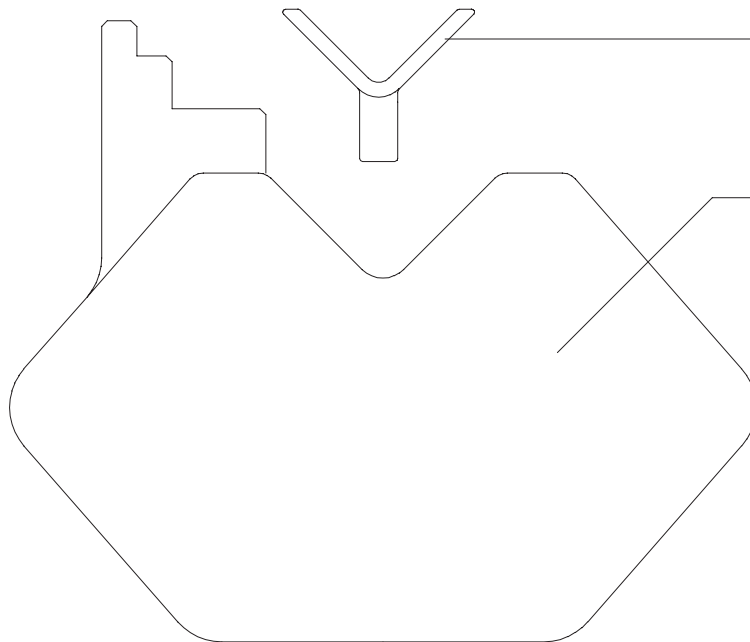

R035,17

R022,01