

# Manfrotto nord

ART.  
515MV

VERSIONE: 001  
DEL: 2002-10-10

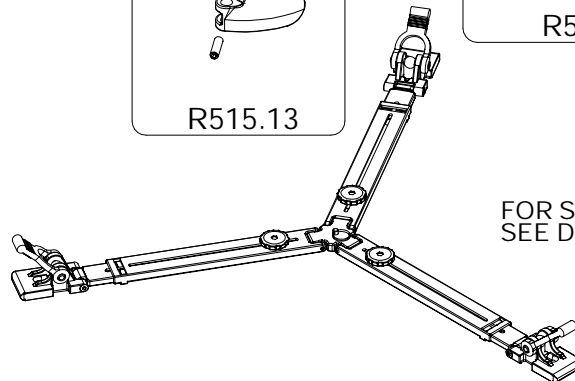
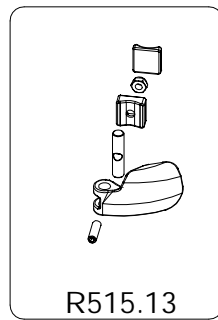
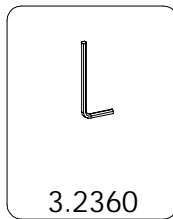
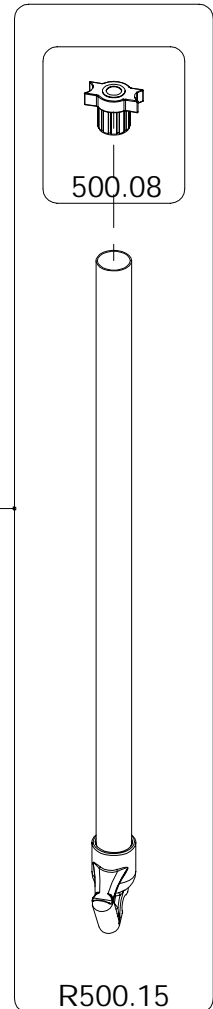
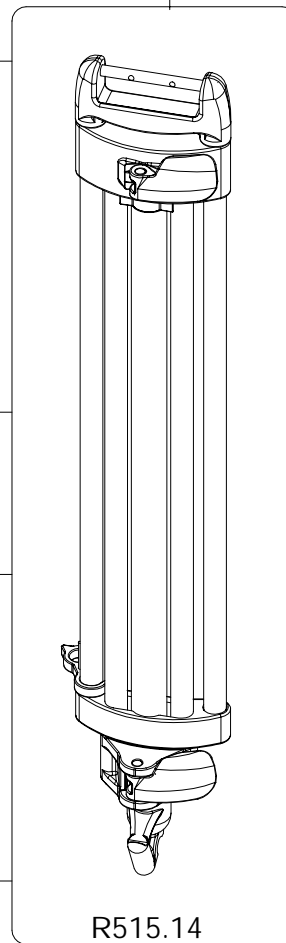
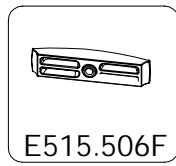
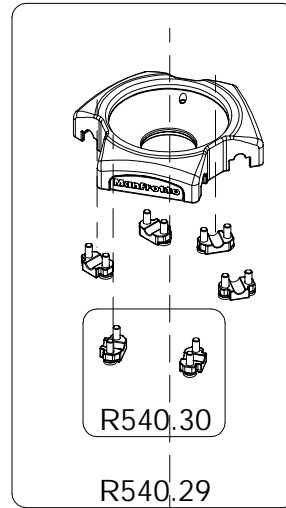
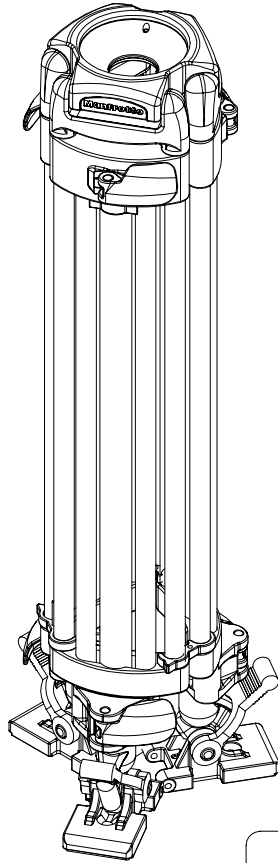

FOR SPREADER SPARE LIST  
SEE DRAWING : ART.165MV